

WRA 200-S8/S17 AUTOMATIC SPRAY GUN



Before use, adjustment or maintenance, it is important to read this instruction manual very carefully. This manual must be stored in a safe place for any future reference that may be necessary.



This **ANEST IWATA** spray guns kit complies to ATEX regulations 94/9/EC.
Protection level: II 2 G X Suitable for using Zones 1 and 2.
X marking: Any static electricity discharge from the spray gun is to be diverted to the ground via the conductive air hose as stipulated.





IMPORTANT

This automatic spray gun should be operated only by an adequately trained operator for safe use and maintenance of the equipment. Any misuse or handling other than those indicated in this Instruction Manual is not covered by guarantee. **ANEST IWATA** disclaims all responsibility for any accident or damage caused by failure observing the operational and safety procedures in this manual. In the interest of user friendliness, this manual contains information in a brief and concise form. For any additional information you may require regarding the automatic spray gun operations, or if any missing parts or any damage during transportation is found, or details of training courses, please contact your nearest **ANEST IWATA Company** (see last cover page).

Be sure to observe warnings and cautions in this instruction manual.

If not, it can cause paint ejection and serious bodily injury by drawing organic solvent.

Be sure to observe following  marked items which are especially important.

 WARNING	Indicates a potentially hazardous situation which, if not avoided, may result in serious injury or loss of life.
 CAUTION	Indicates a potentially hazardous situation which, if not avoided, may result in minor or moderate injury or property damage.
IMPORTANT	Indicates notes which we ask you to observe. The safety precautions in this instruction manual are the minimum necessary conditions. Follow national and local regulations regarding fire prevention, electricity and safety as well as your own company regulations.

IMPORTANT SPECIFICATIONS

Max. Pressure:	6.8 bar (98 PSI)	Max. Temperature:	
Noise Level (LAeqT):	76.8 dB (A) WRA 200 S8 *	Atmosphere	5 ~ 40 °C
Noise Level (LAeqT):	82.4 dB (A) WRA 200 S17 *	Air and fluid	5 ~ 43 °C
		Air connection:	Rc 1/8"
		Fluid connection:	Rc 1/8"

* Measuring point: 1m backwards from gun, 1,6 m height

TECHNICAL SPECIFICATIONS

Model	Nozzle orifice mm(in)	Air Cap Set Mark	Air pressure at gun inlet bar (PSI)		Fluid output ml/m (cfm)	Air consumption	Pattern width mm	Weight g (lbs)
			Atomizing air	Fan air				
WRA-200 Pressure feed								
WRA-200-S8	1.2 (0.047)	LV2	2.4 (34)	2.7 (38)	500	530 (18.7)	400 (15.7)	460 (1.03)
WRA-200-S17-08P	0.8 (0.031)				150		200 (7.9)	
WRA-200-S17-10P	1.0 (0.039)	WB1	1.5 (21)	2.0 (28)	200	420 (14.8)	240 (9.4)	
WRA-200-S17-12P	1.2 (0.047)				250		260 (10.2)	

Manufactured by:

ANEST IWATA Corporation 3176,Shinyoshida-cho, Kohoku-ku, Yokohama, 223-8501 Japan



ANEST IWATA Europe S.r.l.
Corso Vigevano, 46 - 10155, Torino (Italy)
Direct Tel. +39 011 - 22 74 402
Fax +39 011 - 22 74 000
info@anest-iwataeu.com
www.anest-iwataeu.com

ANEST IWATA Italia S.r.l.
Corso Vigevano, 46 - 10155, Torino (Italy)
Tel. diretto +39 011 - 24 80 868 - Fax: +39 011 - 85 19 44
info@anest-iwata.it www.anest-iwata.it

ANEST IWATA Iberica
Calle de Les Teixidores, 3-5
08918 - Badalona (Barcelona)
Tel.:+34 93 32 05 993 - Fax.:+34 93 32 05 965
info@anest-iwata.es www.anest-iwata.es

ANEST IWATA Deutschland
Mommensenstrasse 5
04329 Leipzig
Telefon: +49 (0)341 241 44 30 - Fax: +49 (0)341 252 55 95
info@anest-iwata.de www.anest-iwata.de







European Sales Branches:

ANEST IWATA Scandinavia
Ögärdesvägen 6C, 433 30 PARTILLE - Sweden
Tel. +46 (0)31 - 340 28 60 - Fax +46 (0)31 - 340 28 69
info@anest-iwata.se www.anest-iwata.se

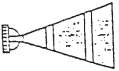
ANEST IWATA France
25 rue de Madrid - 38070 St Quentin Fallavier - France
Tel. +33 (0)4 - 74 94 59 69 - Fax +33 (0)4 - 74 94 34 39
info@anest-iwata.fr www.anest-iwata.fr

ANEST IWATA U.K.
Unit 10 Little End Road - Eaton Socon
St. Neots - CAMBRIDGESHIRE
PE19 8JH
Tel.: +44 (0) 1480 40 54 19 Fax: +44 (0) 1480 21 76 10
enquiries@anest-iwata.co.uk www.anest-iwata.co.uk

TROUBLESHOOTING

Spray Pattern	Problems	Remedies
 Fluttering	1. Air enters between fluid nozzle and tapered seat of gun body. 2. Air enters at fluid hose joint	1. Remove fluid nozzle to clean seat. If it is damaged, replace nozzle. 2. Fully tighten joint section.
 Crescent	1. Paint buildup on air cap partially clogs horn holes. Air pressure from both horns differs.	1. Remove obstructions from horn holes. But do not use metal objects to clean horn holes.
 Inclined	1. Paint buildup or damage on fluid nozzle circumference and air cap center. 2. Fluid nozzle is not properly fitted.	1. Remove obstructions. Replace if damaged. 2. Remove fluid nozzle, clean seated section.
 Split	1. Paint viscosity too low. 2. Fluid output too high.	1. Add paint to increase viscosity. 2. Tighten fluid adj. knob to reduce fluid output or reduce air pressure for Fan.
 Heavy Center	1. Paint viscosity is too high. 2. Fluid output is too low.	1. Add thinner to reduce viscosity. 2. Turn fluid adj. knob counter-clockwise to increase fluid output or increase air pressure for Fan.
 Spit	1. Fluid nozzle and fluid needle set are not seated properly. 2. Paint buildup inside air cap set.	1. Clean or replace fluid nozzle and fluid needle set. 2. Clean air cap set.

PROBLEMS AND REMEDIES

Problem	Where it occurred	Parts to be checked	Cause	Remedy			
				Retighten	Adjust	Clean	Replace
Paint leaks	Fluid nozzle	Fluid nozzle fluid needle	* Dirt or damage, wear on seat surface			x	x
			* Wear on needle spring				x
	Fluid needle packing	Fluid needle packing-packing seat	* Needle does not return due to paint buildup on fluid needle.		x	x	
			* Wear				x
Paint does not flow	Gun body set-Manifold unit	Bolt with hex. hole	* Insufficient tightening	x			
			* Insufficient tightening	x			
	Tip of gun	Fluid adj. knob.	* Insufficient opening		x		
		Tip hole of nozzle	* Clogged			x	
		Paint filter	* Clogged			x	x

HOW TO CONNECT

IMPORTANT THIS GUN SHOULD BE OPERATED BY ADEQUATELY TRAINED OPERATORS ONLY. ENSURE THAT THE GUN HAS NOT BEEN DAMAGED DURING TRANSPORTATION.



CAUTION

- Use clean air filtered through air dryer and air filter. If not, dirty air can cause painting failure.
- When you use this gun for the first time after purchasing, clean fluid passages spraying thinner to remove rust preventive oil. If not, remaining preventive oil can cause painting failure such as fish eyes.
- Use two-way or three-way solenoid valve of more than $\phi 4$ inner dia. cross-sectional area and air hose of over $\phi 6$ inner dia. and less than 10m length. If not, small dia. of solenoid valve and longer air hose between three-way solenoid valve and gun can cause delay in operation.
- Firmly fix hose to spray gun. If not, disconnection of hose can cause bodily injury.

1. Fit the gun to fitting stay, aim at spraying direction and fix it with fixing bolts.
2. Connect atomizing air hose to atomizing air inlet (CAP marked side) fan air hose to fan air inlet (FAN marked side) and operating air hose to operating air inlet (CYL marked side) tightly.
3. Connect fluid hose to fluid inlet (FLU marked side) tightly.
4. Flush the gun fluid passages with a compatible solvent.
5. Supply paint, test spray and adjust fluid output, air volume and pattern width.

CONNECTING EXAMPLE

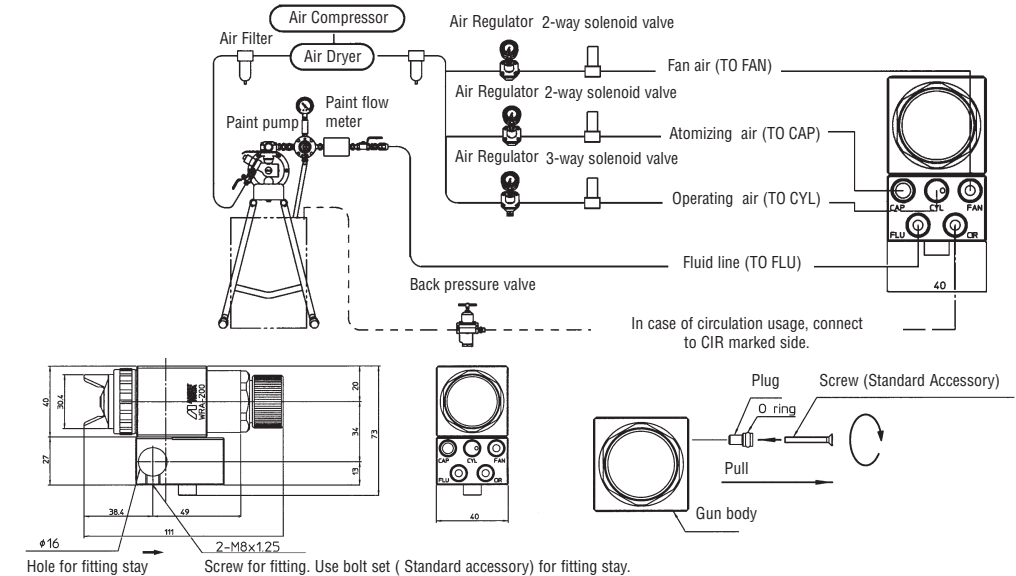

HOW TO CHANGE UNIONS FOR CIRCULATION USAGE

IMPORTANT

1. If the hex. nut is connected to outlet (CIR marked side on manifold) remove it from gun body with 5 mm allen wrench.
2. Divide gun unit to gun body set and manifold unit.
3. Pull plug out from gun body, with attached screw as standard accessory.
4. Set o'ring as standard accessory to fluid passage where removed plug.
5. Tighten gun body set and manifold unit with hex. bolt tightly with manifold packing between them.
6. Connect fitting joint tightly to circulation side (CIR).
7. Connect fluid hose to the joint.

HOW TO OPERATE

Suggested operating air pressure is 3 to 4 bar (43 to 57 PSI).

NOTE: Valve orifice inside two-way or three-way solenoid valve should be minimum 4mm (0.157 in) and also operating air hose length should be within 10m (32.8ft) with the inner diameter more than 6mm (0.236in) to avoid delayed operation and any kind of failure.

Each air pressure for atomizing or fan, varies according to spray conditions, adjust as specified on above specifications table.

Recommended paint viscosity differs according to paint property and painting conditions. 15 to 23 sec/Ford cup# 4 is recommended.

Set the spray distance from the gun to the work piece as near as possible within the range of 150-250 mm (5.9-9.8 in).

MAINTENANCE AND INSPECTION



WARNING

- First release air and fluid pressure fully according to item No. 3 of "Improper use of equipment" of WARNING on page 2.
- Tip of fluid needle set has a sharp point. Do not touch the tip of needle valve during maintenance for protection of the human body.
- Be careful not to damage the tip of the fluid nozzle or not put your hand on it.
- Only an experienced person who is fully conversant with the equipment can do maintenance and inspection.



CAUTION

- Never use commercial or other parts instead of ANEST IWATA original spare parts.
- Never immerse the whole gun into liquid such as thinner.
- Never soak air cap set in solvent for extended period even if cleaning. It can cause defective pattern.
- Never damage holes of air cap, fluid nozzle or fluid needle.

Step-by-step procedure	Important
1. Clean fluid passages and air cap set. Spray a small amount of thinner to clean fluid passages.	1. Incomplete cleaning can fail pattern shape and uniform particles. Especially clean fully and promptly after use with two-component paint.
2. Clean each section with brush soaked with thinner and wipe out with waste cloth.	2. Do not immerse the whole gun in thinner. If done, it can damage parts. When cleaning, never scratch any holes of air cap set, fluid nozzle, or fluid needle set.
3. Before disassembly, fully clean fluid passages.	3. During disassembly, do not scratch seat section.
(1) Disassemble fluid nozzle. Use ring spanner, box wrench or optional exclusive spanner to disassemble fluid nozzle.	(1) Remove fluid nozzle after removing fluid needle set or while keeping fluid needle pulled, in order to protect seat section.
(2) Disassemble fluid needle set. Remove fluid adj. set and pull out fluid needle set from gun body. Pay attention so that spring does not suddenly fly out since fluid adj. set is strongly pushed by fluid needle spring and piston spring.	(2) Pull fluid needle set after loosening fluid needle packing set to protect fluid needle packing set.
Where to inspect	Parts replacement standard
1. Each hole passage of air cap and fluid nozzle	Replace if it is crushed or deformed.
2. Packings and O rings	Replace if it is deformed or worn out.
3. Leakage from seat section between fluid nozzle and fluid needle set	Replace them if leakage does not stop after fully cleaning fluid nozzle and fluid needle set. If you replace fluid nozzle or fluid needle only, fully match them and confirm that there is no leakage.

SPARE PARTS LIST

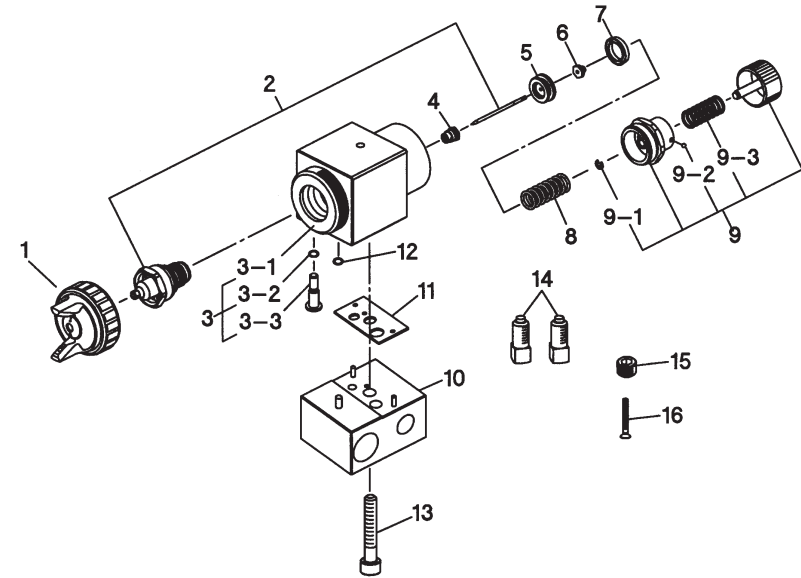

DESCRIPTION	REF.
Air cap set	1
Fluid nozzle-needle set	2 ●
Gun body set	3
Gun body	3-1
O'ring	3-2
Plug	3-3
Fluid needle packing set	4 ●
Piston	5
Needle screw	6
Piston packing	7 ●
Piston spring	8
Fluid adj. set	9
Stop ring	9-1
Ball	9-2
Fluid adj. spring	9-3
Manifold unit	10
Manifold packing	11
O'ring	12
Bolt with hex. hole	13
Fixing bolt set	14
Bolt with hexagon hole	15
Screw	16

Model	Fluid nozzle		Fluid needle
	Orifice Ø mm (in)	Mark	Mark
WRA-200 S8	1.2 (0.047)	WA200/12	WRA12
WRA-200 S17-08P	0.8 (0.031)	WA200/08	WRA08
WRA-200 S17-10P	1.0 (0.039)	WA200/10	WRA10
WRA-200 S17-12P	1.2 (0.047)	WA200/12	WRA12

● Marked parts are wearable parts.

- When ordering parts, specify gun's model, part name with ref. No, and marked No. of air cap set, fluid nozzle and fluid needle set.
- When replacing fluid nozzle and/or fluid needle, please order nozzle needle set.